

**DIGIFLEX® DIGITAL SERVO DRIVES  
WITH CANopen INTERFACE  
MODEL: DC201E100A40NDC**

**FEATURES:**

- Fully digital, state-of-the-art DSP design
- Brushed DC, brushless DC and AC drive technology
- 10 kHz digital current loop, 5 kHz digital velocity loop, 5 kHz digital position loop with programmable gain settings
- Encoder and Hall sensor feedback for sinusoidal commutation
- Surface-mount technology
- Small size, low cost, ease of use
  
- Isolated CAN bus interface for setup and networking
- Supports CANopen communication protocol (DS301) and Device Profile for Drives and Motion Control commands (DSP-402)
- CAN bus address and bit rate selection via DIP-switches
- Windows© based DigiFlex® DriveWare setup software via CAN interface (operates with third party PC-to-CAN interface)
- Operates in torque, velocity or position mode
  
- Single encoder input
- 3 programmable isolated digital inputs (sinking), sourcing inputs optional (-SRC).
- 3 programmable isolated digital outputs (sinking)
- Dedicated isolated limit and home switch inputs
- 2 programmable analog inputs (14-bit)
- 1 programmable analog output (10-bit)
  
- Four quadrant regenerative operation
- Bi-color LED status indicator
- Extensive built-in protection against:
  - over-voltage
  - under-voltage
  - short-circuit: phase-phase, phase-ground
  - over-current
  - over-temperature

Note: picture for reference only.



**BLOCK DIAGRAM:**

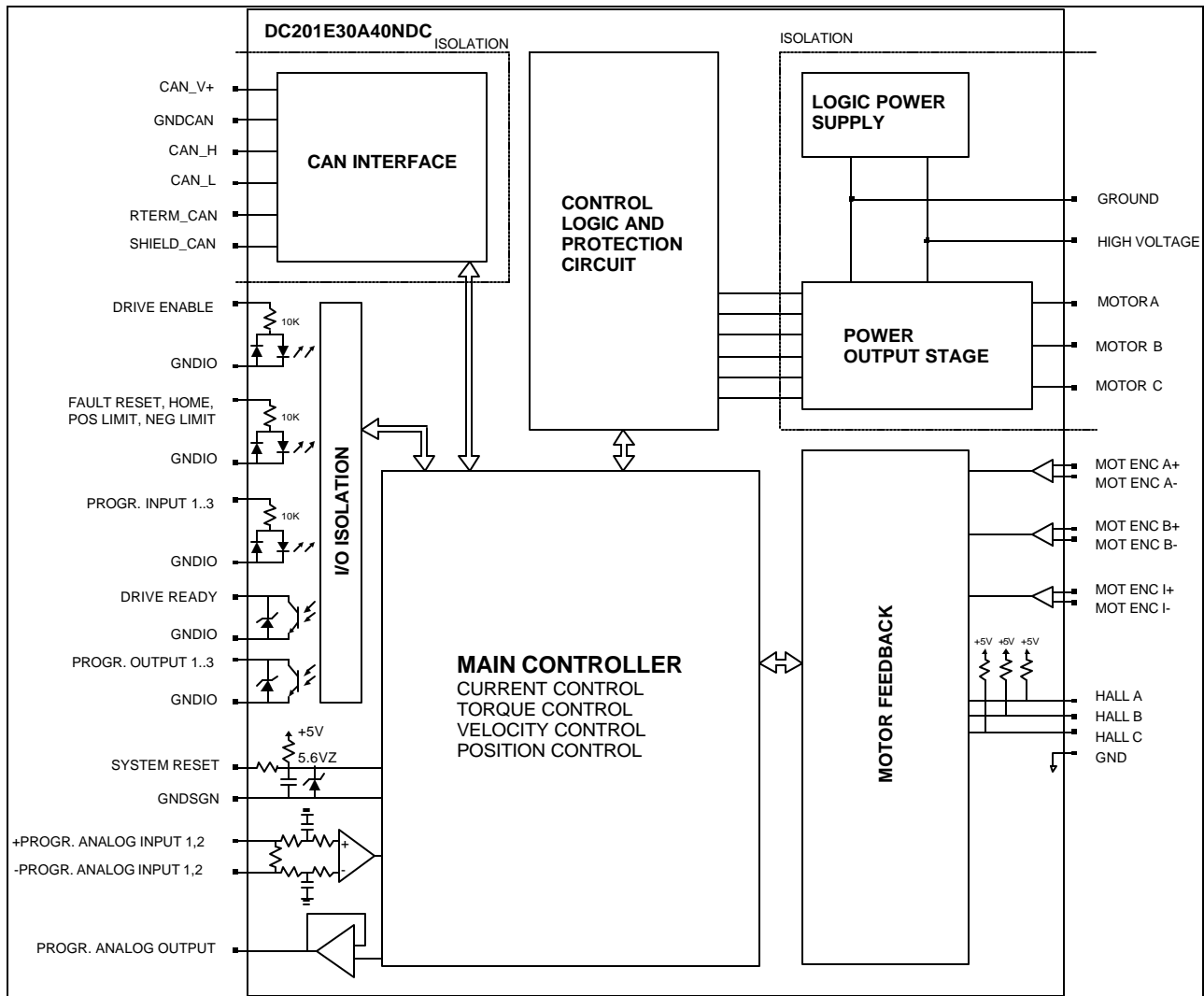

**DESCRIPTION:**

The DC201E Series digital PWM servo drives are designed to drive brushed and brushless servomotors. These fully digital drives can operate in torque, velocity, or position mode. Various feedback signals can be used to close the velocity and position loop. The command source can be generated internally or can be supplied externally. In addition to motor control, these drives feature dedicated and programmable digital and analog inputs and outputs to enhance interfacing with external controllers and devices.

DC201E Series drives feature a single CAN interface which supports the CANopen protocol (DS301 and DSP402). This interface is used for drive configuration and setup as well as online operation in networked applications. Drive commissioning can be accomplished through DigiFlex® DriveWare, a fully graphical Windows® based application.

Torque, velocity, or position commands can be generated from an analog input, a preset index table, or the CAN interface. The DC201E Series also feature an interpolated position mode with cubic interpolation for smooth, coordinated, multi-axis position control via the CAN interface. A homing routine based on the home switch input and/or the encoder index pulse is also implemented.

All drive and motor parameters are stored in non-volatile memory.

**SPECIFICATIONS:**

| <b>POWER STAGE SPECIFICATIONS</b>       | <b>DC201E100A40NDC</b>        |
|---|-------------------------------|
| DC SUPPLY VOLTAGE                       | 60 – 400VDC                   |
| PEAK CURRENT                            | 100A (70.7Arms)               |
| MAXIMUM CONTINUOUS CURRENT              | 50A (35.3Arms)                |
| MINIMUM LOAD INDUCTANCE                 | 600 $\mu$ H                   |
| SWITCHING FREQUENCY                     | 20 kHz                        |
| HEATSINK (BASEPLATE) TEMPERATURE RANGE  | 0 to 65 °C, disables at 65 °C |
| POWER DISSIPATION AT CONTINUOUS CURRENT | 400W                          |
| MIN. UNDER-VOLTAGE SHUTDOWN             | 55 VDC                        |
| MAX. OVER-VOLTAGE SHUTDOWN              | 439 VDC                       |

| <b>CAN INTERFACE SUPPLY SPECIFICATIONS</b> |               |
|--|---------------|
| DC SUPPLY VOLTAGE                          | 7.5 to 13 VDC |
| INPUT CURRENT                              | 150 mA max.   |

| <b>MECHANICAL SPECIFICATIONS</b>     |  |
|--------------------------------------|--|
| POWER CONNECTOR: P1                  | Screw terminal   |
| MOTOR FEEDBACK CONNECTOR: CN3*       | 15-pin high density female D-sub                       |
| I/O CONNECTOR: CN2*                  | 26-pin high density female D-sub                       |
| COMMUNICATIONS INTERFACE (CAN): CN1* | 9-pin male D-sub                                       |
| SIZE                                 | 10.65 x 9.14 x 4.05 inches<br>270.5 x 232.1 x 102.8 mm |
| WEIGHT                               | 11.6 lbs.<br>5.3 kg                                    |

\* Mating connectors are not included.

**PIN FUNCTIONS:**

P1 - Motor and Power Connector:

| CONNECTOR | PIN | NAME         | DESCRIPTION    | I/O    |
|-----------|-----|--------------|----------------|--------|
| P1        | 1   | MA           | Motor phase A  | O      |
|           | 2   | MB           | Motor phase B  | O      |
|           | 3   | MC           | Motor phase C  | O      |
|           | 4   | POWER GND    | Power ground.  | GNDPWR |
|           | 5   | HIGH VOLTAGE | DC power input | I      |

CN3 - Motor Feedback Connector:

| CONNECTOR | PIN | NAME            | DESCRIPTION   | I/O    |
|-----------|-----|-----------------|---|--------|
| CN3       | 1   | MOT ENC A+      | Differential Encoder Input                                  | I      |
|           | 2   | MOT ENC A-      |   | I      |
|           | 3   | MOT ENC B+      | Differential Encoder Input                                  | I      |
|           | 4   | MOT ENC B-      |   | I      |
|           | 5   | GNDSGN          | Signal ground   | GNDSGN |
|           | 6   | Hall A          | Commutation sensor inputs. Internal 2K pull-up to +5VDC.    | I      |
|           | 7   | Hall B          |   | I      |
|           | 8   | Hall C          |   | I      |
|           | 9   | -               | Not connected   |        |
|           | 10  | -               | Not connected   |        |
|           | 11  | MOT ENC I+      | Differential Encoder Input                                  | I      |
|           | 12  | MOT ENC I-      |   | I      |
|           | 13  | +5V OUT         | +5V @ 400mA max. Short-circuit protected.                   | O      |
|           | 14  | MOTOR OVER TEMP | TTL input   | I      |
|           | 15  | SHIELD          | Motor feedback cable shield. Internally connected to GNDSGN | SHLD   |

CN2 – I/O Connector:

| CONNECTOR | PIN | NAME          | DESCRIPTION  | I/O |
|-----------|-----|---------------|--|-----|
| CN2       | 1   | +24V IN       | +24V input pull-up (for sourcing inputs option only)             | I   |
|           | 2   | PROG INPUT 1  | Programmable digital input. Opto-isolated. See schematic below.  | I   |
|           | 3   | PROG INPUT 3  |  | I   |
|           | 4   | FAULT RESET   | Fault reset input. Opto-isolated. See schematic below.           | I   |
|           | 5   | PROG OUTPUT 2 | Programmable digital output. Opto-isolated. See schematic below. | O   |

|    |                       |   |        |
|----|-----------------------|---|--------|
| 6  | -                     | Reserved  |        |
| 7  | -PROG ANALOG INPUT 1  | See pin 16, 17  | I      |
| 8  | -PROG ANALOG INPUT 2  |   | I      |
| 9  | GNDSGN                | Signal ground.  | GNDSGN |
| 10 | +24V IN               | +24V input pull-up (for sourcing inputs option only)                                  | I      |
| 11 | HOME SWITCH           | Home switch input. Opto-isolated. See schematic below.                                | I      |
| 12 | PROG INPUT 2          | Programmable digital input. Opto-isolated. See schematic below.                       | I      |
| 13 | DRIVE ENABLE          | Drive enable input. Opto-isolated. See schematic below.                               | I      |
| 14 | PROG OUTPUT 1         | Programmable digital output. Opto-isolated. See schematic below.                      | O      |
| 15 | PROG OUTPUT 3         |   | O      |
| 16 | +PROG ANALOG INPUT 1  | Programmable analog input. Opto-isolated. See schematic below.                        | I      |
| 17 | +PROG ANALOG INPUT 2  |   | I      |
| 18 | SYSTEM RESET          | TTL input. Pull to ground to reset drive (same as power cycle). Referenced to GNDSGN. | I      |
| 19 | NEGATIVE LIMIT SWITCH | Negative limit switch input. Opto-isolated. See schematic below.                      | I      |
| 20 | POSITIVE LIMIT SWITCH | Positive limit switch input. Opto-isolated. See schematic below.                      | I      |
| 21 | DRIVE READY           | Drive ready output. Opto-isolated. See schematic below.                               | O      |
| 22 | GNDIO                 | Isolated ground   | GNDIO  |
| 23 | GNDIO                 | Isolated ground   | GNDIO  |
| 24 | GNDA                  | Analog signal ground. Internally connected to GNDSGN                                  | GNDA   |
| 25 | PROG ANALOG OUTPUT 1  | Programmable analog output. See schematic below.                                      | O      |
| 26 | SHIELD                | Cable shield. Internally connected to GNDSGN  | SHLD   |

I/O SCHEMATICS:

- Isolated Outputs

DRIVE READY, PROGRAMMABLE OUTPUT 1...3

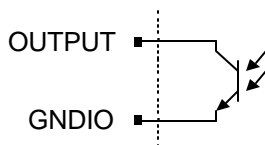

|                          |          |
|--------------------------|----------|
| Active maximum voltage   | +0.7 VDC |
| Active maximum current   | 200 mA   |
| Inactive maximum voltage | +30 VDC  |
| Inactive maximum current | 0.01 mA  |

- Isolated Inputs

DRIVE ENABLE, FAULT RESET, HOME SWITCH, POSITIVE LIMIT SWITCH, NEGATIVE LIMIT SWITCH, PROGRAMMABLE INPUT 1...3

- Sinking Inputs (standard version)

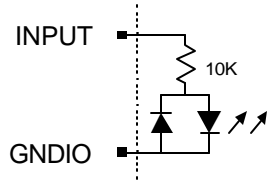

|                          |          |
|--------------------------|----------|
| Active maximum voltage   | +30 VDC  |
| Active minimum voltage   | +18 VDC  |
| Inactive maximum voltage | +2.5 VDC |
| Inactive minimum voltage | -5VDC    |

- Sourcing Inputs (optional -SRC version)

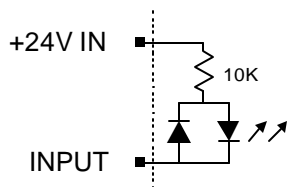

|                          |                |
|--------------------------|----------------|
| Active maximum voltage   | +10VDC         |
| Active minimum voltage   | -5VDC          |
| Inactive maximum voltage | +24VIN + 5VDC  |
| Inactive minimum voltage | +24VIN -2.5VDC |

- Programmable Analog Output

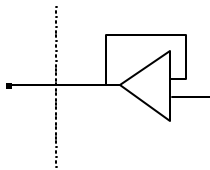

|                         |             |
|-------------------------|-------------|
| Voltage Range           | -10V...+10V |
| Resolution              | 10-bit      |
| Minimum Load Resistance | 2K Ohm      |

- Programmable Analog Inputs

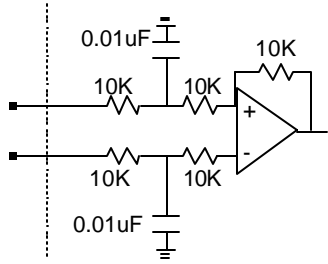

|               |            |
|---------------|------------|
| Voltage Range | 10V...+10V |
| Resolution    | 12-bit     |

- System Reset Input

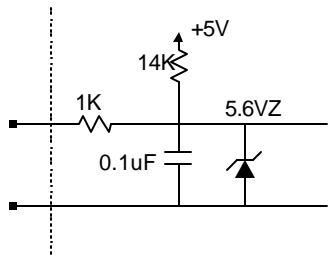

CN1 - Communications Interface (CAN):

| CONNECTOR | PIN | NAME     | DESCRIPTION   | I/O  |
|-----------|-----|----------|---|------|
| CN1       | 2   | CAN_L    | CAN_L bus line (dominant low)                                   | I    |
|           | 3   | CAN_GND  | CAN ground  | GND  |
|           | 5   | CAN_SHLD | CAN shield  | SHLD |
|           | 7   | CAN_H    | CAN_H bus line (dominant high)                                  | I    |
|           | 8   | CAN_TERM | Termination. Connect to CAN_H for CAN bus termination (120 Ohm) | GND  |
|           | 9   | CAN_V+   | CAN external supply 7.5...13 VDC                                | I    |

**DIP SWITCH FUNCTIONS:**

- CAN Address Setting

| Node-ID | SW1 | SW2 | SW3 | SW4 | SW5 | SW6 |
|---------|-----|-----|-----|-----|-----|-----|
| Via CAN | OFF | OFF | OFF | OFF | OFF | OFF |
| 1       | ON  | OFF | OFF | OFF | OFF | OFF |
| 2       | OFF | ON  | OFF | OFF | OFF | OFF |
| 3       | ON  | ON  | OFF | OFF | OFF | OFF |
| ...     |     |     |     |     |     |     |

|    |    |    |    |    |    |    |
|----|----|----|----|----|----|----|
| 63 | ON | ON | ON | ON | ON | ON |
|----|----|----|----|----|----|----|

- CAN Bus Bit Rate Setting

| Bit Rate (bits/sec) | SW7 | SW8 |
|---------------------|-----|-----|
| Via CAN             | OFF | OFF |
| 500K                | OFF | ON  |
| 250K                | ON  | OFF |
| 125K                | ON  | ON  |

- CAN Bus Termination

SW10 can be used for CAN bus termination. Setting SW10 ON will internally connect the CAN\_H signal to CAN\_L via a 120Ω resistor. This can be used if the drive is the last node in a CAN network. Setting SW10 OFF will open this termination. Note: the CAN\_TERM pin can also be used for termination, see below.

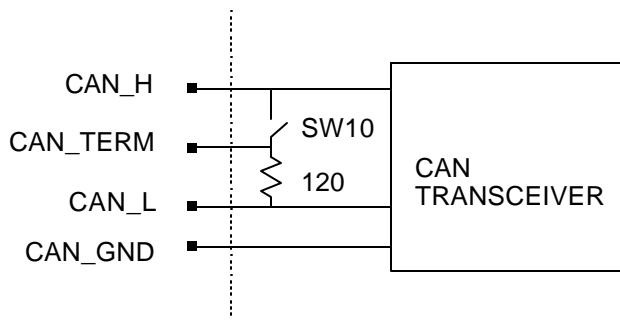

**DIGIFLEX® DRIVEWARE:**

DigiFlex® DriveWare is a Windows® based application that can be used to setup and configure the DigiFlex® series of digital servo drives via the CAN interface. This application operates with the following PC-to-CAN interfaces:

| Manufacturer    | Part Number | Style   | Manufacturer Contact Information                                     |
|-----------------|-------------|---------|--|
| Advantech       | PCL-841     | ISA-bus | <a href="http://www.advantech.com">www.advantech.com</a>             |
| IXXAT           | any         | any     | <a href="http://www.ixxat.com">www.ixxat.com</a>                     |
| Kvaser          | any         | any     | <a href="http://www.kvaser.com">www.kvaser.com</a>                   |
| ESD Electronics | any         | any     | <a href="http://www.esd-electronics.com">www.esd-electronics.com</a> |

**CANopen OBJECT DICTIONARY:**

For more detailed information on CANopen, please visit <http://www.can-cia.org/>, the official web site of CAN in Automation (CiA), the governing body of the CANopen standard.

I. Communication Profile Objects (DS301):

- 1000h: Device\_Type
- 1001h: Error\_register
- 1002h: Manufacturer\_Status\_Register
- 1008h: Manufacturer\_Device\_Name

1009h: Manufacturer\_Hardware\_Version  
100Ah: Manufacturer\_Software\_Version  
100Ch: guard-time  
100Dh: life-time factor  
1010h: store\_parameters  
1400h: 1<sup>st</sup> receive pdo communication parameter  
1401h: 2<sup>nd</sup> receive pdo communication parameter  
1402h: 3<sup>rd</sup> receive pdo communication parameter  
1403h: 4<sup>th</sup> receive pdo communication parameter  
1404h: 5<sup>th</sup> receive pdo communication parameter  
1414h: 21<sup>st</sup> receive pdo communication parameter  
1415h: 22<sup>nd</sup> receive pdo communication parameter  
1416h: 23<sup>rd</sup> receive pdo communication parameter  
1417h: 24<sup>th</sup> receive pdo communication parameter  
1600h: 1<sup>st</sup> receive pdo mapping parameter  
1601h: 2<sup>nd</sup> receive pdo mapping parameter  
1602h: 3<sup>rd</sup> receive pdo mapping parameter  
1603h: 4<sup>th</sup> receive pdo mapping parameter  
1604h: 5<sup>th</sup> receive pdo mapping parameter  
1614h: 21<sup>st</sup> receive pdo mapping parameter  
1615h: 22<sup>nd</sup> receive pdo mapping parameter  
1616h: 23<sup>rd</sup> receive pdo mapping parameter  
1617h: 24<sup>th</sup> receive pdo mapping parameter  
1800h: 1<sup>st</sup> transmit pdo communication parameter  
1802h: 3<sup>rd</sup> transmit pdo communication parameter  
1803h: 4<sup>th</sup> transmit pdo communication parameter  
1804h: 5<sup>th</sup> transmit pdo communication parameter  
1814h: 21<sup>st</sup> transmit pdo communication parameter  
1815h: 22<sup>nd</sup> transmit pdo communication parameter  
1816h: 23<sup>rd</sup> transmit pdo communication parameter  
1817h: 24<sup>th</sup> transmit pdo communication parameter  
1818h: 25<sup>th</sup> transmit pdo communication parameter  
1819h: 26<sup>th</sup> transmit pdo communication parameter  
1A00h: 1<sup>st</sup> transmit pdo mapping parameter  
1A02h: 3<sup>rd</sup> transmit pdo mapping parameter  
1A03h: 4<sup>th</sup> transmit pdo mapping parameter  
1A04h: 5<sup>th</sup> transmit pdo mapping parameter  
1A14h: 21<sup>st</sup> transmit pdo mapping parameter  
1A15h: 22<sup>nd</sup> transmit pdo mapping parameter  
1A16h: 23<sup>rd</sup> transmit pdo mapping parameter  
1A17h: 24<sup>th</sup> transmit pdo mapping parameter  
1A18h: 25<sup>th</sup> transmit pdo mapping parameter  
1A19h: 26<sup>th</sup> transmit pdo mapping parameter

## II. Drive Profile Objects (DSP402)

- Common Objects

6402h: motor\_type  
6403h: motor\_catalogue\_number  
6404h: motor\_manufacturer  
6410h: motor\_data  
6510h: drive\_data  
6502h: supported\_drive\_modes  
6503h: drive\_catalogue\_number  
6504h: drive\_manufacturer

2001h: user\_defined\_drive\_name  
2002h: user\_units  
200Eh: active\_non\_fatal\_errors  
200Fh: error\_self\_reset  
2011h: commutation\_sensor\_selection\_code  
2012h: hall\_sensor\_parameters  
201Fh: hall\_sensor\_error\_option\_code  
2031h: hall\_sensor\_error\_counter  
2032h: hall\_sensor\_error\_counter\_limit  
2013h: encoder\_parameters  
2020h: encoder\_counter  
2021h: encoder\_position  
2022h: encoder\_index\_counter  
2027h: encoder\_error\_option\_code  
2023h: encoder\_error\_counter  
2024h: encoder\_error\_counter\_limit  
2014h: auxiliary\_encoder\_parameters  
2028h: auxiliary\_encoder\_counter  
2029h: auxiliary\_encoder\_position  
202Ah: auxiliary\_encoder\_index\_counter  
2030h: auxiliary\_encoder\_error\_option\_code  
202Bh: auxiliary\_encoder\_error\_counter  
202Ch: auxiliary\_encoder\_error\_counter\_limit  
2040h: DIP-switch\_settings  
20A0h: programmable\_digital\_inputs  
20A1h: programmable\_digital\_outputs  
20A2h : programmable\_analog\_inputs  
20A3h: programmable\_analog\_outputs  
20A4h: programmable\_digital\_inputs\_polarity  
20A5h: programmable\_digital\_inputs\_function  
20A8h: programmable\_digital\_outputs\_polarity  
20A9h: programmable\_digital\_outputs\_function  
20ACh : programmable\_analog\_input\_parameters  
20AEh: programmable\_analog\_output\_parameters  
20C2h: power\_stage\_temperature  
20C8h: communication\_control  
208Fh: load\_inertia

- Device Control Objects

6040h: controlword  
20C4h: controlword\_initial\_value  
20C5h: auxiliary\_controlword  
6041h: statusword  
605Ah: quick\_stop\_option\_code  
605Bh: shutdown\_option\_code  
605Ch: disable\_operation\_option\_code  
6060h: modes\_of\_operation  
6061h: modes\_of\_operation display  
2000h: statusword\_1  
2004h: dedicated\_digital\_inputs  
2005h: dedicated\_digital\_outputs  
2006h: dedicated\_digital\_inputs\_polarity  
2007h: dedicated\_digital\_outputs\_polarity  
2049h: invert\_command

20B0h: trigger\_at\_value  
 20B1h: capture\_value  
 20B3h: trigger\_signal  
 20B5h: capture\_signal  
 20B6h: capture\_event  
 20C1h: delay\_times  
 20C3h: motor\_overtemperature\_option\_code

- Factor Group Objects

6090h: velocity\_encoder\_resolution  
 608Fh: position\_encoder\_resolution  
 6093h: position\_factor  
 6094h: velocity\_encoder\_factor  
 6097h: acceleration\_factor  
 2079h: analog\_torque\_command\_factor  
 207Ah: digital\_torque\_command\_factor  
 2081h: analog\_velocity\_command\_factor  
 2082h: digital\_velocity\_command\_factor  
 2091h: analog\_position\_command\_factor  
 2092h: digital\_position\_command\_factor

- Profile Position Mode Objects

607Ah: target\_position  
 607Dh: software\_position\_limit  
 6086h: motion\_profile\_type  
 607Fh: maximum\_profile\_velocity  
 6081h: profile\_velocity  
 6083h: profile\_acceleration  
 6084h: profile\_deceleration  
 6085h: Quick\_stop\_deceleration

- Homing Mode Objects

607Ch: home\_offset  
 6098h: homing\_method  
 6099h: homing\_speeds  
 609Ah: homing\_acceleration

- Position Control Function Objects

6062h: position\_demand\_value  
 6063h: position\_actual\_value\*  
 6064h: position\_actual\_value  
 6067h: position\_window  
 6068h: position\_window\_time  
 6065h: following\_error\_window  
 6066h: following\_error\_time\_out  
 60F4h: following\_error\_actual\_value  
 60FBh: position\_control\_parameter\_set  
 60FCh: position\_demand\_value\*  
 2090h: demand\_position\_offset  
 2093h: position\_command\_low\_pass\_filter

- Profile Velocity Mode Objects

6069h: velocity\_sensor\_actual\_value  
606Ah: sensor\_selection\_code  
606Bh: velocity\_demand\_value  
606Ch: velocity\_actual\_value  
606Dh: velocity\_window  
606Eh: velocity\_window\_time  
606Fh: velocity\_threshold  
6070h: velocity\_threshold\_time  
60F9h: velocity\_control\_parameter\_set  
60FFh: target\_velocity  
2080h: demand\_velocity\_offset  
2083h: velocity\_command\_low\_pass\_filter  
2084h: velocity\_error

- Profile Torque Mode Objects

6071h: target\_torque  
6072h: max\_torque  
6074h: torque\_demand\_value  
6075h: motor\_rated\_current  
6076h: motor\_rated\_torque  
6077h: torque\_actual\_value  
6078h: current\_actual\_value  
6079h: dc\_link\_circuit\_voltage  
6087h: torque\_slope  
6088h: torque\_profile\_type  
60F8h: torque\_control\_parameters  
2010h: rated\_voltage  
2070h: current\_control\_parameter\_set  
2074h: target\_current\_q  
2075h: reference\_current\_q  
2077h: reference\_torque  
2078h: rated\_torque\_constant  
207Bh: Torque command low pass filter

**ORDERING INFORMATION:**

Standard model: DC201E 100A40NDCX

With sourcing inputs: DC201E 100A40NDCX-SRC

X indicates the current revision letter.

**MOUNTING DIMENSIONS:**

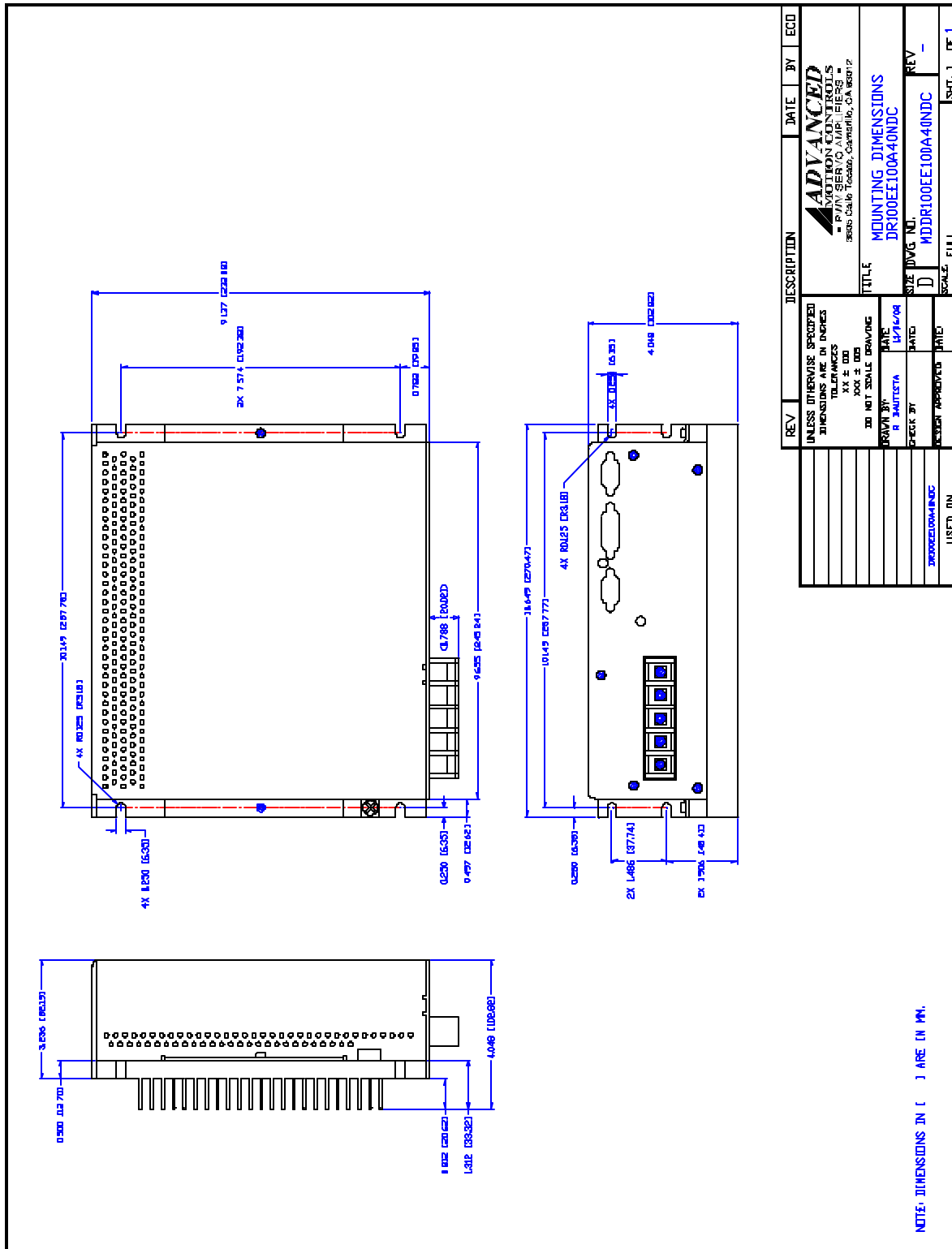

NOTE: DIMENSIONS IN [ ] ARE IN MM.

| REV | DESCRIPTION   | DATE             | BY | ECO  |
|-----|---|------------------|----|------|
|     | UNLESS OTHERWISE SPECIFIED<br>DIMENSIONS ARE IN INCHES<br>TOLERANCES<br>XX ± .00<br>XXX ± .00                                   |                  |    |      |
|     | DO NOT SCALE DRAWING  |                  |    |      |
|     | DRAWN BY<br>R BAUTISTA  | DATE<br>11/16/08 |    |      |
|     | CHECK BY  | DATE             |    |      |
|     | DESIGN APPROVED   | DATE             |    |      |
|     | 3RD PARTY APPROVED<br>USED ON   |                  |    |      |
|     | <b>ADVANCED</b><br>MOTION CONTROLS<br>4000 SHERBORN AVE. #1000<br>SAN JOSE, CA 95131<br>9505 Calle Trabuco, Carmelito, CA 95017 |                  |    |      |
|     | TITLE<br>MOUNTING DIMENSIONS  |                  |    |      |
|     | DR100EE100A40NDC  |                  |    |      |
|     | SIZE DVG NO.  |                  |    |      |
|     | D MDDR100EE100A40NDC  |                  |    |      |
|     | REV   |                  |    |      |
|     | SCALE: FULL   |                  |    |      |
|     | SHT. 1  |                  |    | OF 1 |