

## DIGIFLEX® DIGITAL SERVO DRIVES WITH CANopen INTERFACE MODEL: DC201E30A40LAC

### FEATURES:

- Fully digital, state-of-the-art DSP design
- Brushed DC, brushless DC and AC drive technology
- Digital current, velocity, and position loops with programmable gain settings
- Hall sensor and encoder based sinusoidal commutation for brushless motors
- Surface-mount technology
- Small size, low cost, ease of use
  
- Isolated CAN bus interface for setup and networking
- Supports CANopen communication protocol (DS301) and Device Profile for Drives and Motion Control commands (DSP-402)
- CAN bus address and bit rate selection via DIP-switches
- Windows© based DigiFlex® DriveWare setup software via CAN interface (operates with third party PC-to-CAN interface)
- Operates in torque, velocity or position mode
  
- Single encoder input
- 3 programmable isolated digital inputs (sinking), sourcing inputs optional (-SRC).
- 3 programmable isolated digital outputs (sinking)
- Dedicated isolated limit and home switch inputs
- 2 programmable analog inputs (14-bit)
- 1 programmable analog output (10-bit)
  
- Four quadrant regenerative operation
- Separate logic supply
- Built-in shunt regulator (external shunt resistor)
- Bi-color LED status indicator
- Extensive built-in protection against:
  - over-voltage
  - under-voltage
  - short-circuit: phase-phase, phase-ground
  - over-current
  - over-temperature



**\*Photo for reference only**

**BLOCK DIAGRAM:**

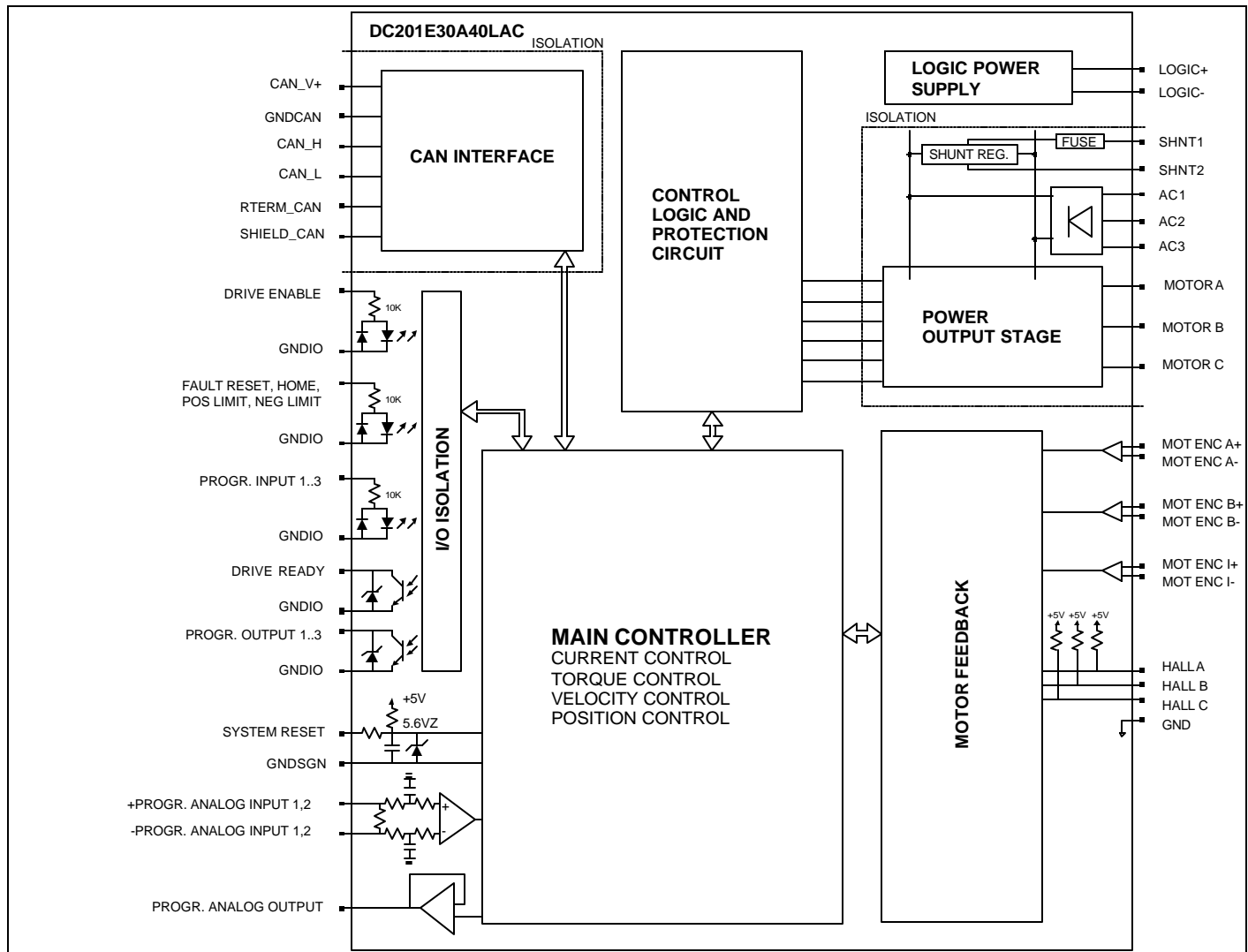

**DESCRIPTION:**

The DC201E Series digital PWM servo drives are designed to drive brushed and brushless servomotors. These fully digital drives can operate in torque, velocity, or position mode. Various feedback signals can be used to close the velocity and position loop. The command source can be generated internally or can be supplied externally. In addition to motor control, these drives feature dedicated and programmable digital and analog inputs and outputs to enhance interfacing with external controllers and devices.

DC201E Series drives feature a single CAN interface which supports the CANopen protocol (DS301 and DSP402). This interface is used for drive configuration and setup as well as online operation in networked applications. Drive commissioning can be accomplished through DigiFlex® DriveWare, a fully graphical Windows© based application.

Torque, velocity, or position commands can be generated from an analog input, a preset index table, or the CAN interface. The DC201E Series also feature an interpolated position mode with cubic interpolation for smooth, coordinated, multi-axis position control via the CAN interface. A homing routine based on the home switch input and/or the encoder index pulse is also implemented.

All drive and motor parameters are stored in non-volatile memory.

**SPECIFICATIONS:**

<b>POWER STAGE SPECIFICATIONS</b>	<b>DC201E30A40LAC</b>
AC SUPPLY VOLTAGE	40 – 270 VAC, 3-phase, 50 – 60 Hz
PEAK CURRENT	30A (21.2 Arms)
MAXIMUM CONTINUOUS CURRENT	15A (10.6 Arms)
MINIMUM LOAD INDUCTANCE	600 $\mu$ H
SWITCHING FREQUENCY	20 kHz
HEATSINK (BASEPLATE) TEMPERATURE RANGE	0 to 65 °C, disables at 65 °C
POWER DISSIPATION AT CONTINUOUS CURRENT	200W
MIN. UNDER-VOLTAGE SHUTDOWN	55 VDC
MAX. OVER-VOLTAGE SHUTDOWN	439 VDC
BUS CAPACITANCE	1410 $\mu$ F
SHUNT RESISTOR	External
SHUNT SWITCH-ON VOLTAGE	Programmable
SHUNT FUSE	3A Motor Delay @ 250VAC
LOGIC SUPPLY VOLTAGE	20...30 VDC

<b>CAN INTERFACE SUPPLY SPECIFICATIONS</b>	
DC SUPPLY VOLTAGE	7.5 to 13 VDC
INPUT CURRENT	150 mA max.

<b>MECHANICAL SPECIFICATIONS</b>	
POWER CONNECTOR: P	Screw terminal
LOGIC SUPPLY CONNECTOR: P	2-pin; 5.08mm pitch removable with screw flange
MOTOR FEEDBACK CONNECTOR: CN3	15-pin high density female D-sub
I/O CONNECTOR: CN2	26-pin high density female D-sub
COMMUNICATIONS INTERFACE (CAN): CN1	9-pin male D-sub
SIZE	7.95 x 6.18 x 2.76 inches 202x 157 x 70 mm
WEIGHT	3 lbs. 1.5 Kg

**PIN FUNCTIONS:**

P - Motor and Power Connector:

CONNECTOR	PIN	NAME	DESCRIPTION	I/O
P	1	MA	Motor phase A	O
	2	MB	Motor phase B	O
	3	MC	Motor phase C	O
	4	SHNT1	External shunt resistor connection	O
	5	SHNT2		O
	6	AC1	AC supply input. 40 – 270 VAC, single or 3-phase.	I
	7	AC2		I
	8	AC3		I

P – Logic Supply Connector:

CONNECTOR	PIN	NAME	DESCRIPTION	I/O
P	1	RTN AUX	Logic supply ground	GND
	2	PWR AUX	Logic supply power	I

CN3 - Motor Feedback Connector:

CONNECTOR	PIN	NAME	DESCRIPTION	I/O
CN3	1	MOT ENC A+	Differential Encoder Input	I
	2	MOT ENC A-		I
	3	MOT ENC B+	Differential Encoder Input	I
	4	MOT ENC B-		I
	5	GNDSGN	Signal ground	GNDSGN
	6	Hall A	Commutation sensor inputs. Internal 2K pull-up to +5VDC.	I
	7	Hall B		I
	8	Hall C		I
	9	-	Not connected	
	10	-	Not connected	
	11	MOT ENC I+	Differential Encoder Input	I
	12	MOT ENC I-		I
	13	+5V OUT	+5V @ 400mA max. Short-circuit protected.	O
	14	MOTOR OVER TEMP	TTL input	I
	15	SHIELD	Motor feedback cable shield. Internally connected to GNDSGN	SHLD

CN2 – I/O Connector:

CONNECTOR	PIN	NAME	DESCRIPTION	I/O
CN2	1	+24V IN	+24V input pull-up (for sourcing inputs option only)	I
	2	PROG INPUT 1	Programmable digital input. Opto-isolated. See schematic below.	I
	3	PROG INPUT 3		I
	4	FAULT RESET	Fault reset input. Opto-isolated. See schematic below.	I
	5	PROG OUTPUT 2	Programmable digital output. Opto-isolated. See schematic below.	O
	6	-	Reserved	
	7	-PROG ANALOG INPUT 1	See pin 16, 17	I
	8	-PROG ANALOG INPUT 2		I
	9	GNDSGN	Signal ground.	GNDSGN
	10	+24V IN	+24V input pull-up (for sourcing inputs option only)	I
	11	HOME SWITCH	Home switch input. Opto-isolated. See schematic below.	I
	12	PROG INPUT 2	Programmable digital input. Opto-isolated. See schematic below.	I
	13	DRIVE ENABLE	Drive enable input. Opto-isolated. See schematic below.	I
	14	PROG OUTPUT 1	Programmable digital output. Opto-isolated. See schematic below.	O
	15	PROG OUTPUT 3		O
	16	+PROG ANALOG INPUT 1	Programmable analog input. Opto-isolated. See schematic below.	I
	17	+PROG ANALOG INPUT 2		I
	18	SYSTEM RESET	TTL input. Pull to ground to reset drive (same as power cycle). Referenced to GNDSGN.	I
	19	NEGATIVE LIMIT SWITCH	Negative limit switch input. Opto-isolated. See schematic below.	I
	20	POSITIVE LIMIT SWITCH	Positive limit switch input. Opto-isolated. See schematic below.	I
	21	DRIVE READY	Drive ready output. Opto-isolated. See schematic below.	O
	22	GNDIO	Isolated ground	GNDIO
	23	GNDIO	Isolated ground	GNDIO
	24	GNDA	Analog signal ground. Internally connected to GNDSGN	GNDA
	25	PROG ANALOG OUTPUT 1	Programmable analog output. See schematic below.	O
	26	SHIELD	Cable shield. Internally connected to GNDSGN	SHLD

I/O SCHEMATICS:

- Isolated Outputs

DRIVE READY, PROGRAMMABLE OUTPUT 1...3

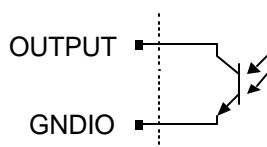

Active maximum voltage	+0.7 VDC
Active maximum current	200 mA
Inactive maximum voltage	+30 VDC
Inactive maximum current	0.01 mA

- Isolated Inputs

DRIVE ENABLE, FAULT RESET, HOME SWITCH, POSITIVE LIMIT SWITCH, NEGATIVE LIMIT SWITCH, PROGRAMMABLE INPUT 1...3

- Sinking Inputs (standard version)

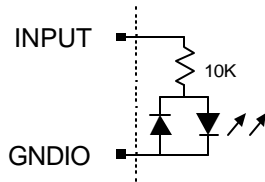

Active maximum voltage	+30 VDC
Active minimum voltage	+18 VDC
Inactive maximum voltage	+2.5 VDC
Inactive minimum voltage	-5VDC

- Sourcing Inputs (optional -SRC version)

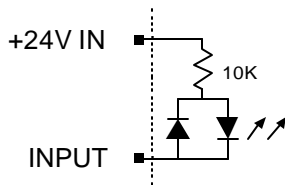

Active maximum voltage	+10VDC
Active minimum voltage	-5VDC
Inactive maximum voltage	+24VIN + 5VDC
Inactive minimum voltage	+24VIN -2.5VDC

- Programmable Analog Output

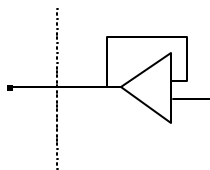

Voltage Range	-10V...+10V
Resolution	10-bit
Minimum Load Resistance	2K Ohm

- Programmable Analog Inputs

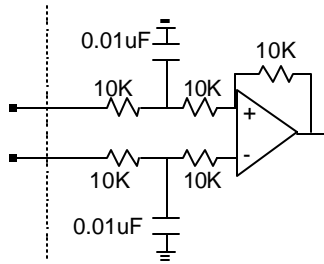

Voltage Range	10V...+10V
Resolution	12-bit

- System Reset Input

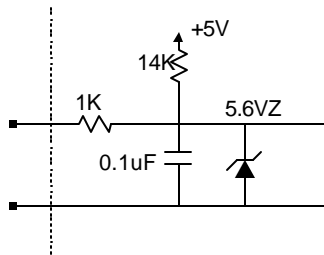

CN1 - Communications Interface (CAN):

CONNECTOR	PIN	NAME	DESCRIPTION	I/O
CN1	2	CAN_L	CAN_L bus line (dominant low)	I
	3	CAN_GND	CAN ground	GND
	5	CAN_SHLD	CAN shield	SHLD
	7	CAN_H	CAN_H bus line (dominant high)	I
	8	CAN_TERM	Termination. Connect to CAN_H for CAN bus termination (120 Ohm)	GND
	9	CAN_V+	CAN external supply 7.5...13 VDC	I

**DIP SWITCH FUNCTIONS:**

- CAN Address Setting

Node-ID	SW1	SW2	SW3	SW4	SW5	SW6
Via CAN	OFF	OFF	OFF	OFF	OFF	OFF
1	ON	OFF	OFF	OFF	OFF	OFF
2	OFF	ON	OFF	OFF	OFF	OFF
3	ON	ON	OFF	OFF	OFF	OFF
...						

63	ON	ON	ON	ON	ON	ON
----	----	----	----	----	----	----

• CAN Bus Bit Rate Setting

Bit Rate (bits/sec)	SW7	SW8
Via CAN	OFF	OFF
500K	OFF	ON
250K	ON	OFF
125K	ON	ON

• CAN Bus Termination

SW10 can be used for CAN bus termination. Setting SW10 ON will internally connect the CAN\_H signal to CAN\_L via a 120Ω resistor. This can be used if the drive is the last node in a CAN network. Setting SW10 OFF will open this termination. Note: the CAN\_TERM pin can also be used for termination, see below.

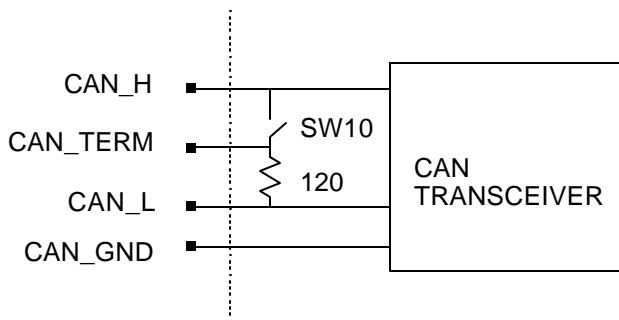

**DIGIFLEX® DRIVEWARE:**

DigiFlex® DriveWare is a Windows© based application that can be used to setup and configure the DigiFlex® series of digital servo drives via the CAN interface. This application operates with the following PC-to-CAN interfaces:

Manufacturer	Part Number	Style	Manufacturer Contact Information
Advantech	PCL-841	ISA-bus	<a href="http://www.advantech.com">www.advantech.com</a>
ESD Electronics	CAN-PCC*	PC Centronics (parallel port)	<a href="http://www.esd-electronics.com">www.esd-electronics.com</a>

\* Also operates with other PC-to-CAN interface cards (e.g. PCI, PC104, ...).

**CANopen OBJECT DICTIONARY:**

For more detailed information on CANopen, please visit <http://www.can-cia.org/>, the official web site of CAN in Automation (CiA), the governing body of the CANopen standard.

I. Communication Profile Objects (DS301):

- 1000h: Device\_Type
- 1001h: Error\_register
- 1002h: Manufacturer\_Status\_Register
- 1008h: Manufacturer\_Device\_Name

1009h: Manufacturer\_Hardware\_Version  
 100Ah: Manufacturer\_Software\_Version  
 100Ch: guard-time  
 100Dh: life-time factor  
 1010h: store\_parameters  
 1400h: 1<sup>st</sup> receive pdo communication parameter  
 1401h: 2<sup>nd</sup> receive pdo communication parameter  
 1402h: 3<sup>rd</sup> receive pdo communication parameter  
 1403h: 4<sup>th</sup> receive pdo communication parameter  
 1404h: 5<sup>th</sup> receive pdo communication parameter  
 1414h: 21<sup>st</sup> receive pdo communication parameter  
 1415h: 22<sup>nd</sup> receive pdo communication parameter  
 1416h: 23<sup>rd</sup> receive pdo communication parameter  
 1417h: 24<sup>th</sup> receive pdo communication parameter  
 1600h: 1<sup>st</sup> receive pdo mapping parameter  
 1601h: 2<sup>nd</sup> receive pdo mapping parameter  
 1602h: 3<sup>rd</sup> receive pdo mapping parameter  
 1603h: 4<sup>th</sup> receive pdo mapping parameter  
 1604h: 5<sup>th</sup> receive pdo mapping parameter  
 1614h: 21<sup>st</sup> receive pdo mapping parameter  
 1615h: 22<sup>nd</sup> receive pdo mapping parameter  
 1616h: 23<sup>rd</sup> receive pdo mapping parameter  
 1617h: 24<sup>th</sup> receive pdo mapping parameter  
 1800h: 1<sup>st</sup> transmit pdo communication parameter  
 1802h: 3<sup>rd</sup> transmit pdo communication parameter  
 1803h: 4<sup>th</sup> transmit pdo communication parameter  
 1804h: 5<sup>th</sup> transmit pdo communication parameter  
 1814h: 21<sup>st</sup> transmit pdo communication parameter  
 1815h: 22<sup>nd</sup> transmit pdo communication parameter  
 1816h: 23<sup>rd</sup> transmit pdo communication parameter  
 1817h: 24<sup>th</sup> transmit pdo communication parameter  
 1818h: 25<sup>th</sup> transmit pdo communication parameter  
 1819h: 26<sup>th</sup> transmit pdo communication parameter  
 1A00h: 1<sup>st</sup> transmit pdo mapping parameter  
 1A02h: 3<sup>rd</sup> transmit pdo mapping parameter  
 1A03h: 4<sup>th</sup> transmit pdo mapping parameter  
 1A04h: 5<sup>th</sup> transmit pdo mapping parameter  
 1A14h: 21<sup>st</sup> transmit pdo mapping parameter  
 1A15h: 22<sup>nd</sup> transmit pdo mapping parameter  
 1A16h: 23<sup>rd</sup> transmit pdo mapping parameter  
 1A17h: 24<sup>th</sup> transmit pdo mapping parameter  
 1A18h: 25<sup>th</sup> transmit pdo mapping parameter  
 1A19h: 26<sup>th</sup> transmit pdo mapping parameter

## II. Drive Profile Objects (DSP402)

- Common Objects

6402h: motor\_type  
 6403h: motor\_catalogue\_number  
 6404h: motor\_manufacturer  
 6410h: motor\_data  
 6510h: drive\_data  
 6502h: supported\_drive\_modes  
 6503h: drive\_catalogue\_number  
 6504h: drive\_manufacturer

2001h: user\_defined\_drive\_name  
2002h: user\_units  
200Eh: active\_non\_fatal\_errors  
200Fh: error\_self\_reset  
2011h: commutation\_sensor\_selection\_code  
2012h: hall\_sensor\_parameters  
201Fh: hall\_sensor\_error\_option\_code  
2031h: hall\_sensor\_error\_counter  
2032h: hall\_sensor\_error\_counter\_limit  
2013h: encoder\_parameters  
2020h: encoder\_counter  
2021h: encoder\_position  
2022h: encoder\_index\_counter  
2027h: encoder\_error\_option\_code  
2023h: encoder\_error\_counter  
2024h: encoder\_error\_counter\_limit  
2014h: auxiliary\_encoder\_parameters  
2028h: auxiliary\_encoder\_counter  
2029h: auxiliary\_encoder\_position  
202Ah: auxiliary\_encoder\_index\_counter  
2030h: auxiliary\_encoder\_error\_option\_code  
202Bh: auxiliary\_encoder\_error\_counter  
202Ch: auxiliary\_encoder\_error\_counter\_limit  
2040h: DIP-switch\_settings  
20A0h: programmable\_digital\_inputs  
20A1h: programmable\_digital\_outputs  
20A2h : programmable\_analog\_inputs  
20A3h: programmable\_analog\_outputs  
20A4h: programmable\_digital\_inputs\_polarity  
20A5h: programmable\_digital\_inputs\_function  
20A8h: programmable\_digital\_outputs\_polarity  
20A9h: programmable\_digital\_outputs\_function  
20ACh : programmable\_analog\_input\_parameters  
20AEh: programmable\_analog\_output\_parameters  
20C2h: power\_stage\_temperature  
20C8h: communication\_control  
208Fh: load\_inertia

- Device Control Objects

6040h: controlword  
20C4h: controlword\_initial\_value  
20C5h: auxiliary\_controlword  
6041h: statusword  
605Ah: quick\_stop\_option\_code  
605Bh: shutdown\_option\_code  
605Ch: disable\_operation\_option\_code  
6060h: modes\_of\_operation  
6061h: modes\_of\_operation display  
2000h: statusword\_1  
2004h: dedicated\_digital\_inputs  
2005h: dedicated\_digital\_outputs  
2006h: dedicated\_digital\_inputs\_polarity  
2007h: dedicated\_digital\_outputs\_polarity  
2049h: invert\_command

20B0h: trigger\_at\_value  
20B1h: capture\_value  
20B3h: trigger\_signal  
20B5h: capture\_signal  
20B6h: capture\_event  
20C1h: delay\_times  
20C3h: motor\_overtemperature\_option\_code

- Factor Group Objects

6090h: velocity\_encoder\_resolution  
608Fh: position\_encoder\_resolution  
6093h: position\_factor  
6094h: velocity\_encoder\_factor  
6097h: acceleration\_factor  
2079h: analog\_torque\_command\_factor  
207Ah: digital\_torque\_command\_factor  
2081h: analog\_velocity\_command\_factor  
2082h: digital\_velocity\_command\_factor  
2091h: analog\_position\_command\_factor  
2092h: digital\_position\_command\_factor

- Profile Position Mode Objects

607Ah: target\_position  
607Dh: software\_position\_limit  
6086h: motion\_profile\_type  
607Fh: maximum\_profile\_velocity  
6081h: profile\_velocity  
6083h: profile\_acceleration  
6084h: profile\_deceleration  
6085h: Quick\_stop\_deceleration

- Homing Mode Objects

607Ch: home\_offset  
6098h: homing\_method  
6099h: homing\_speeds  
609Ah: homing\_acceleration

- Position Control Function Objects

6062h: position\_demand\_value  
6063h: position\_actual\_value\*  
6064h: position\_actual\_value  
6067h: position\_window  
6068h: position\_window\_time  
6065h: following\_error\_window  
6066h: following\_error\_time\_out  
60F4h: following\_error\_actual\_value  
60FBh: position\_control\_parameter\_set  
60FCh: position\_demand\_value\*  
2090h: demand\_position\_offset  
2093h: position\_command\_low\_pass\_filter

- Profile Velocity Mode Objects

6069h: velocity\_sensor\_actual\_value  
606Ah: sensor\_selection\_code  
606Bh: velocity\_demand\_value  
606Ch: velocity\_actual\_value  
606Dh: velocity\_window  
606Eh: velocity\_window\_time  
606Fh: velocity\_threshold  
6070h: velocity\_threshold\_time  
60F9h: velocity\_control\_parameter\_set  
60FFh: target\_velocity  
2080h: demand\_velocity\_offset  
2083h: velocity\_command\_low\_pass\_filter  
2084h: velocity\_error

- Profile Torque Mode Objects

6071h: target\_torque  
6072h: max\_torque  
6074h: torque\_demand\_value  
6075h: motor\_rated\_current  
6076h: motor\_rated\_torque  
6077h: torque\_actual\_value  
6078h: current\_actual\_value  
6079h: dc\_link\_circuit\_voltage  
6087h: torque\_slope  
6088h: torque\_profile\_type  
60F8h: torque\_control\_parameters  
2010h: rated\_voltage  
2070h: current\_control\_parameter\_set  
2074h: target\_current\_q  
2075h: reference\_current\_q  
2077h: reference\_torque  
2078h: rated\_torque\_constant  
207Bh: Torque command low pass filter

**ORDERING INFORMATION:**

Standard model: DC201E30A40LACX

With sourcing inputs: DC201E30A40LACX-SRC

X indicates the current revision letter.

**MOUNTING DIMENSIONS:**