

DIGIFLEX® DIGITAL SERVO DRIVES WITH CANopen INTERFACE MODEL: DC201R30A40NAC

FEATURES:

- Fully digital, state-of-the-art DSP design
- Brushed DC, brushless AC drive technology
- 10 kHz digital current loop, 5 kHz digital velocity loop, 5 kHz digital position loop with programmable gain settings
- Resolver feedback for sinusoidal commutation
- Surface-mount technology
- Small size, low cost, ease of use

- Isolated CAN bus interface for setup and networking
- Supports CANopen communication protocol (DS301) and Device Profile for Drives and Motion Control commands (DSP-402)
- CAN bus address and bit rate selection via DIP-switches
- Windows® based DigiFlex® DriveWare setup software via CAN interface (operates with third party PC-to-CAN interface)
- Operates in torque, velocity or position mode

- Single resolver input
- 3 programmable isolated digital inputs (sinking), sourcing inputs optional (-SRC).
- 3 programmable isolated digital outputs (sinking)
- Dedicated isolated limit and home switch inputs
- 2 programmable analog inputs (14-bit)
- 1 programmable analog output (10-bit)

- Four quadrant regenerative operation
- Built-in shunt regulator (external shunt resistor)
- Bi-color LED status indicator
- Extensive built-in protection against:
 - over-voltage
 - under-voltage
 - short-circuit: phase-phase, phase-ground
 - over-current
 - over-temperature



* Photo for reference only.

BLOCK DIAGRAM:

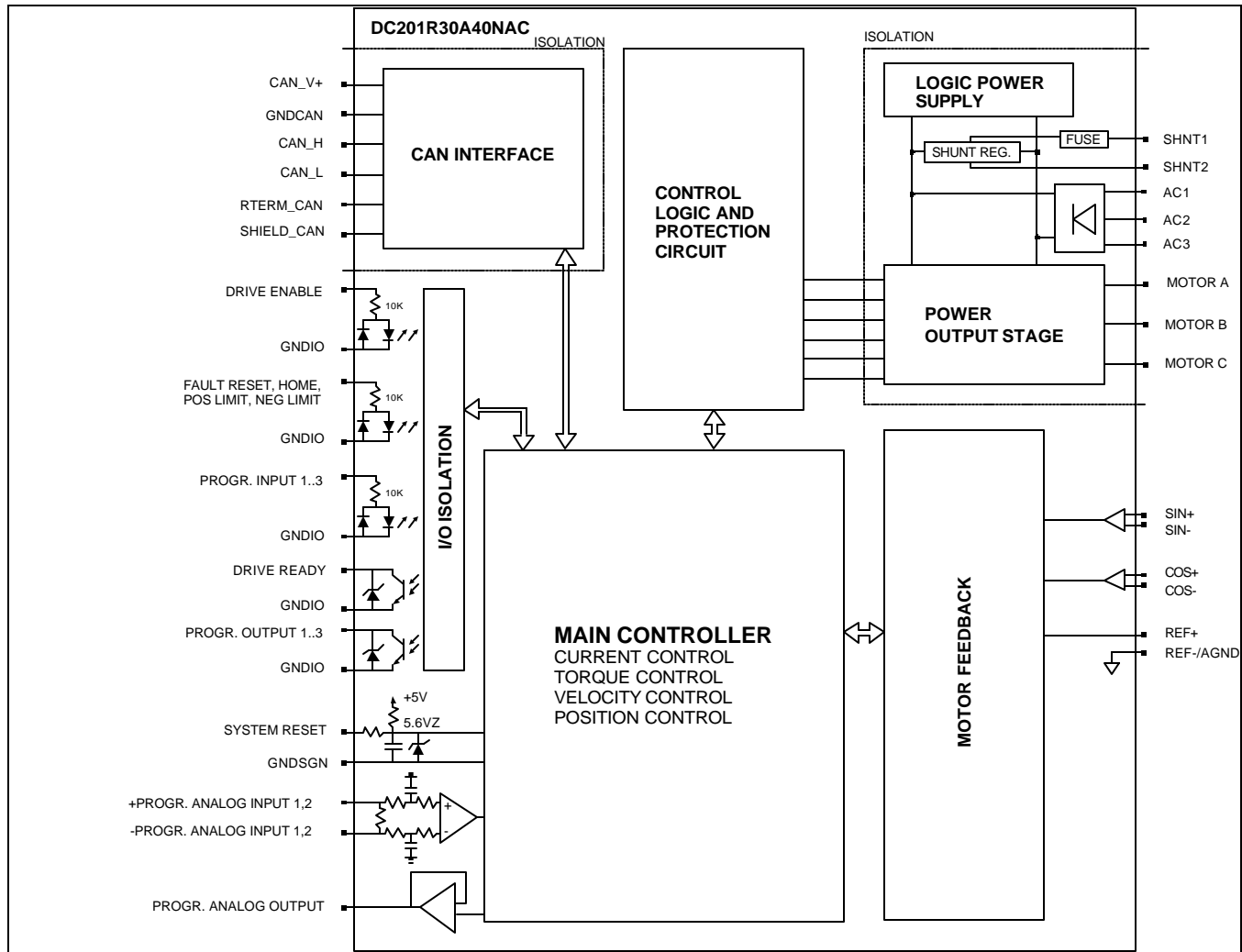

DESCRIPTION:

The DC201R Series digital PWM servo drives are designed to drive brushed and brushless servomotors. These fully digital drives can operate in torque, velocity, or position mode. Various feedback signals can be used to close the velocity and position loop. The command source can be generated internally or can be supplied externally. In addition to motor control, these drives feature dedicated and programmable digital and analog inputs and outputs to enhance interfacing with external controllers and devices.

DC201R Series drives feature a single CAN interface which supports the CANopen protocol (DS301 and DSP402). This interface is used for drive configuration and setup as well as online operation in networked applications. Drive commissioning can be accomplished through DigiFlex® DriveWare, a fully graphical Windows® based application.

Torque, velocity, or position commands can be generated from an analog input, a preset index table, or the CAN interface. The DC201R Series also feature an interpolated position mode with cubic interpolation for smooth, coordinated, multi-axis position control via the CAN interface. A homing routine based on the home switch input and/or the encoder index pulse is also implemented.

All drive and motor parameters are stored in non-volatile memory.

SPECIFICATIONS:

POWER STAGE SPECIFICATIONS	DC201R30A40NAC
AC SUPPLY VOLTAGE	40 – 270 VAC, 3-phase, 50 – 60 Hz
PEAK CURRENT	30A (21.2 Arms)
MAXIMUM CONTINUOUS CURRENT	15A (10.6 Arms)
MINIMUM LOAD INDUCTANCE	600 µH
SWITCHING FREQUENCY	20 kHz
HEATSINK (BASEPLATE) TEMPERATURE RANGE	0 to 65 °C, disables at 65 °C
POWER DISSIPATION AT CONTINUOUS CURRENT	200W
MIN. UNDER-VOLTAGE SHUTDOWN	55 VDC
MAX. OVER-VOLTAGE SHUTDOWN	439 VDC
BUS CAPACITANCE	1410 µF
SHUNT RESISTOR	External
SHUNT SWITCH-ON VOLTAGE	Programmable
SHUNT FUSE	3A Motor Delay @ 250VAC

CAN INTERFACE SUPPLY SPECIFICATIONS	
DC SUPPLY VOLTAGE	7.5 to 13 VDC
INPUT CURRENT	150 mA max.

MECHANICAL SPECIFICATIONS	
POWER CONNECTOR: P1	Screw terminal
MOTOR FEEDBACK CONNECTOR: CN3*	15-pin high density female D-sub
I/O CONNECTOR: CN2*	26-pin high density female D-sub
COMMUNICATIONS INTERFACE (CAN): CN1*	9-pin male D-sub
SIZE	7.95 x 6.18 x 2.76 inches 202x 157 x 70 mm
WEIGHT	3 lbs. 1.5 Kg

* Mating connectors are not included.

PIN FUNCTIONS:

P1 - Motor and Power Connector:

CONNECTOR	PIN	NAME	DESCRIPTION	I/O
P1	1	MA	Motor phase A	O
	2	MB	Motor phase B	O
	3	MC	Motor phase C	O
	4	SHNT1	External shunt resistor connection	O
	5	SHNT2		O
	6	AC1	AC supply input. 40 – 270 VAC, single or 3-phase.	I
	7	AC2		I
	8	AC3		I

CN3 - Motor Feedback Connector:

CONNECTOR	PIN	NAME	DESCRIPTION	I/O
CN3	1	SIN+	Resolver sine input, 2Vrms	I
	2	SIN-		I
	3	COS+	Resolver cosine input, 2Vrms	I
	4	COS-		I
	5	GNDSGN	Signal ground	GNDSGN
	6	-	Not connected	
	7	-	Not connected	
	8	-	Not connected	
	9	-	Not connected	
	10	GND A	Analog ground	GND A
	11	REF+	Resolver reference output, 4Vrms, 50mA, 5kHz	O
	12	REF- (same as GND A)		O
	13	+5V OUT	+5V @ 300mA max. Short-circuit protected.	O
	14	MOTOR OVER TEMP	TTL input	I
	15	SHIELD	Motor feedback cable shield. Internally connected to GNDSGN	SHLD

CN2 – I/O Connector:

CONNECTOR	PIN	NAME	DESCRIPTION	I/O
CN2	1	+24V IN	+24V input pull-up (for sourcing inputs option only)	I
	2	PROG INPUT 1	Programmable digital input. Opto-isolated. See schematic below.	I
	3	PROG INPUT 3		I

4	FAULT RESET	Fault reset input. Opto-isolated. See schematic below.	I
5	PROG OUTPUT 2	Programmable digital output. Opto-isolated. See schematic below.	O
6	-	Reserved	
7	-PROG ANALOG INPUT 1	See pin 16, 17	I
8	-PROG ANALOG INPUT 2		I
9	GNDSGN	Signal ground.	GNDSGN
10	+24V IN	+24V input pull-up (for sourcing inputs option only)	I
11	HOME SWITCH	Home switch input. Opto-isolated. See schematic below.	I
12	PROG INPUT 2	Programmable digital input. Opto-isolated. See schematic below.	I
13	DRIVE ENABLE	Drive enable input. Opto-isolated. See schematic below.	I
14	PROG OUTPUT 1	Programmable digital output. Opto-isolated. See schematic below.	O
15	PROG OUTPUT 3		O
16	+PROG ANALOG INPUT 1	Programmable analog input. Opto-isolated. See schematic below.	I
17	+PROG ANALOG INPUT 2		I
18	SYSTEM RESET	TTL input. Pull to ground to reset drive (same as power cycle). Referenced to GNDSGN.	I
19	NEGATIVE LIMIT SWITCH	Negative limit switch input. Opto-isolated. See schematic below.	I
20	POSITIVE LIMIT SWITCH	Positive limit switch input. Opto-isolated. See schematic below.	I
21	DRIVE READY	Drive ready output. Opto-isolated. See schematic below.	O
22	GNDIO	Isolated ground	GNDIO
23	GNDIO	Isolated ground	GNDIO
24	GNDA	Analog signal ground. Internally connected to GNDSGN	GNDA
25	PROG ANALOG OUTPUT 1	Programmable analog output. See schematic below.	O
26	SHIELD	Cable shield. Internally connected to GNDSGN	SHLD

I/O SCHEMATICS:

- Isolated Outputs

DRIVE READY, PROGRAMMABLE OUTPUT 1...3

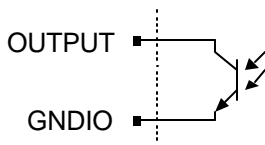

Active maximum voltage	+0.7 VDC
------------------------	----------

Active maximum current	200 mA
Inactive maximum voltage	+30 VDC
Inactive maximum current	0.01 mA

- Isolated Inputs

DRIVE ENABLE, FAULT RESET, HOME SWITCH, POSITIVE LIMIT SWITCH, NEGATIVE LIMIT SWITCH, PROGRAMMABLE INPUT 1...3

- Sinking Inputs (standard version)

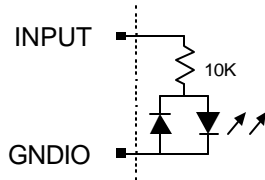

Active maximum voltage	+30 VDC
Active minimum voltage	+18 VDC
Inactive maximum voltage	+2.5 VDC
Inactive minimum voltage	-5VDC

- Sourcing Inputs (optional -SRC version)

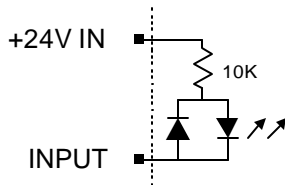

Active maximum voltage	+10VDC
Active minimum voltage	-5VDC
Inactive maximum voltage	+24VIN + 5VDC
Inactive minimum voltage	+24VIN -2.5VDC

- Programmable Analog Output

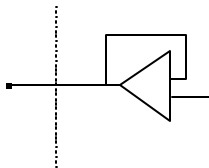

Voltage Range	-10V...+10V
Resolution	10-bit
Minimum Load Resistance	2K Ohm

- Programmable Analog Inputs

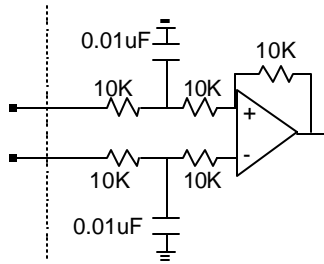

Voltage Range	10V...+10V
Resolution	12-bit

- System Reset Input

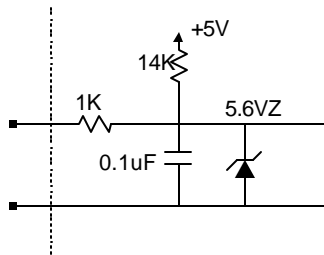

CN1 - Communications Interface (CAN):

CONNECTOR	PIN	NAME	DESCRIPTION	I/O
CN1	2	CAN_L	CAN_L bus line (dominant low)	I
	3	CAN_GND	CAN ground	GND
	5	CAN_SHLD	CAN shield	SHLD
	7	CAN_H	CAN_H bus line (dominant high)	I
	8	CAN_TERM	Termination. Connect to CAN_H for CAN bus termination (120 Ohm)	GND
	9	CAN_V+	CAN external supply 7.5...13 VDC	I

DIP SWITCH FUNCTIONS:

- CAN Address Setting

Node-ID	SW1	SW2	SW3	SW4	SW5	SW6
Via CAN	OFF	OFF	OFF	OFF	OFF	OFF
1	ON	OFF	OFF	OFF	OFF	OFF
2	OFF	ON	OFF	OFF	OFF	OFF
3	ON	ON	OFF	OFF	OFF	OFF
...						

63	ON	ON	ON	ON	ON	ON
----	----	----	----	----	----	----

- CAN Bus Bit Rate Setting

Bit Rate (bits/sec)	SW7	SW8
Via CAN	OFF	OFF
500K	OFF	ON
250K	ON	OFF
125K	ON	ON

- CAN Bus Termination

SW10 can be used for CAN bus termination. Setting SW10 ON will internally connect the CAN_H signal to CAN_L via a 120Ω resistor. This can be used if the drive is the last node in a CAN network. Setting SW10 OFF will open this termination. Note: the CAN_TERM pin can also be used for termination, see below.

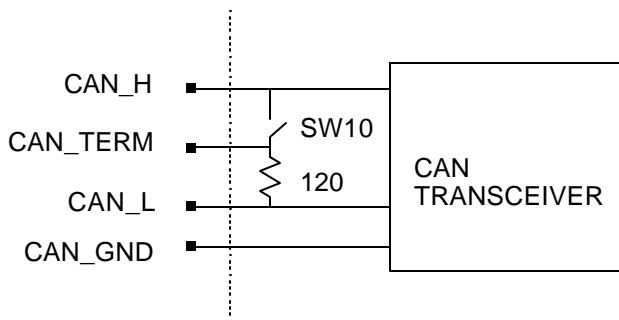

DIGIFLEX® DRIVEWARE:

DigiFlex® DriveWare is a Windows© based application that can be used to setup and configure the DigiFlex® series of digital servo drives via the CAN interface. This application operates with the following PC-to-CAN interfaces:

Manufacturer	Part Number	Style	Manufacturer Contact Information
Advantech	PCL-841	ISA-bus	www.advantech.com
IXXAT	any	any	www.ixxat.com
Kvaser	any	any	www.kvaser.com
ESD Electronics	any	any	www.esd-electronics.com

CANopen OBJECT DICTIONARY:

For more detailed information on CANopen, please visit <http://www.can-cia.org/>, the official web site of CAN in Automation (CiA), the governing body of the CANopen standard.

I. Communication Profile Objects (DS301):

- 1000h: Device_Type
- 1001h: Error_register
- 1002h: Manufacturer_Status_Register
- 1008h: Manufacturer_Device_Name

1009h: Manufacturer_Hardware_Version
 100Ah: Manufacturer_Software_Version
 100Ch: guard-time
 100Dh: life-time factor
 1010h: store_parameters
 1400h: 1st receive pdo communication parameter
 1401h: 2nd receive pdo communication parameter
 1402h: 3rd receive pdo communication parameter
 1403h: 4th receive pdo communication parameter
 1404h: 5th receive pdo communication parameter
 1414h: 21st receive pdo communication parameter
 1415h: 22nd receive pdo communication parameter
 1416h: 23rd receive pdo communication parameter
 1417h: 24th receive pdo communication parameter
 1600h: 1st receive pdo mapping parameter
 1601h: 2nd receive pdo mapping parameter
 1602h: 3rd receive pdo mapping parameter
 1603h: 4th receive pdo mapping parameter
 1604h: 5th receive pdo mapping parameter
 1614h: 21st receive pdo mapping parameter
 1615h: 22nd receive pdo mapping parameter
 1616h: 23rd receive pdo mapping parameter
 1617h: 24th receive pdo mapping parameter
 1800h: 1st transmit pdo communication parameter
 1802h: 3rd transmit pdo communication parameter
 1803h: 4th transmit pdo communication parameter
 1804h: 5th transmit pdo communication parameter
 1814h: 21st transmit pdo communication parameter
 1815h: 22nd transmit pdo communication parameter
 1816h: 23rd transmit pdo communication parameter
 1817h: 24th transmit pdo communication parameter
 1818h: 25th transmit pdo communication parameter
 1819h: 26th transmit pdo communication parameter
 1A00h: 1st transmit pdo mapping parameter
 1A02h: 3rd transmit pdo mapping parameter
 1A03h: 4th transmit pdo mapping parameter
 1A04h: 5th transmit pdo mapping parameter
 1A14h: 21st transmit pdo mapping parameter
 1A15h: 22nd transmit pdo mapping parameter
 1A16h: 23rd transmit pdo mapping parameter
 1A17h: 24th transmit pdo mapping parameter
 1A18h: 25th transmit pdo mapping parameter
 1A19h: 26th transmit pdo mapping parameter

II. Drive Profile Objects (DSP402)

- Common Objects

6402h: motor_type
 6403h: motor_catalogue_number
 6404h: motor_manufacturer
 6410h: motor_data
 6510h: drive_data
 6502h: supported_drive_modes
 6503h: drive_catalogue_number
 6504h: drive_manufacturer

2001h: user_defined_drive_name
 2002h: user_units
 200Eh: active_non_fatal_errors
 200Fh: error_self_reset
 2011h: commutation_sensor_selection_code
 2012h: hall_sensor_parameters
 201Fh: hall_sensor_error_option_code
 2031h: hall_sensor_error_counter
 2032h: hall_sensor_error_counter_limit
 2013h: encoder_parameters
 2020h: encoder_counter
 2021h: encoder_position
 2022h: encoder_index_counter
 2027h: encoder_error_option_code
 2023h: encoder_error_counter
 2024h: encoder_error_counter_limit
 2014h: auxiliary_encoder_parameters
 2028h: auxiliary_encoder_counter
 2029h: auxiliary_encoder_position
 202Ah: auxiliary_encoder_index_counter
 2030h: auxiliary_encoder_error_option_code
 202Bh: auxiliary_encoder_error_counter
 202Ch: auxiliary_encoder_error_counter_limit
 2040h: DIP-switch_settings
 20A0h: programmable_digital_inputs
 20A1h: programmable_digital_outputs
 20A2h : programmable_analog_inputs
 20A3h: programmable_analog_outputs
 20A4h: programmable_digital_inputs_polarity
 20A5h: programmable_digital_inputs_function
 20A8h: programmable_digital_outputs_polarity
 20A9h: programmable_digital_outputs_function
 20ACh : programmable_analog_input_parameters
 20AEh: programmable_analog_output_parameters
 20C2h: power_stage_temperature
 20C8h: communication_control
 208Fh: load_inertia

- Device Control Objects

6040h: controlword
 20C4h: controlword_initial_value
 20C5h: auxiliary_controlword
 6041h: statusword
 605Ah: quick_stop_option_code
 605Bh: shutdown_option_code
 605Ch: disable_operation_option_code
 6060h: modes_of_operation
 6061h: modes_of_operation display
 2000h: statusword_1
 2004h: dedicated_digital_inputs
 2005h: dedicated_digital_outputs
 2006h: dedicated_digital_inputs_polarity
 2007h: dedicated_digital_outputs_polarity
 2049h: invert_command

20B0h: trigger_at_value
20B1h: capture_value
20B3h: trigger_signal
20B5h: capture_signal
20B6h: capture_event
20C1h: delay_times
20C3h: motor_overtemperature_option_code

- Factor Group Objects

6090h: velocity_encoder_resolution
608Fh: position_encoder_resolution
6093h: position_factor
6094h: velocity_encoder_factor
6097h: acceleration_factor
2079h: analog_torque_command_factor
207Ah: digital_torque_command_factor
2081h: analog_velocity_command_factor
2082h: digital_velocity_command_factor
2091h: analog_position_command_factor
2092h: digital_position_command_factor

- Profile Position Mode Objects

607Ah: target_position
607Dh: software_position_limit
6086h: motion_profile_type
607Fh: maximum_profile_velocity
6081h: profile_velocity
6083h: profile_acceleration
6084h: profile_deceleration
6085h: Quick_stop_deceleration

- Homing Mode Objects

607Ch: home_offset
6098h: homing_method
6099h: homing_speeds
609Ah: homing_acceleration

- Position Control Function Objects

6062h: position_demand_value
6063h: position_actual_value*
6064h: position_actual_value
6067h: position_window
6068h: position_window_time
6065h: following_error_window
6066h: following_error_time_out
60F4h: following_error_actual_value
60FBh: position_control_parameter_set
60FCh: position_demand_value*
2090h: demand_position_offset
2093h: position_command_low_pass_filter

- Profile Velocity Mode Objects

6069h: velocity_sensor_actual_value
606Ah: sensor_selection_code
606Bh: velocity_demand_value
606Ch: velocity_actual_value
606Dh: velocity_window
606Eh: velocity_window_time
606Fh: velocity_threshold
6070h: velocity_threshold_time
60F9h: velocity_control_parameter_set
60FFh: target_velocity
2080h: demand_velocity_offset
2083h: velocity_command_low_pass_filter
2084h: velocity_error

- Profile Torque Mode Objects

6071h: target_torque
6072h: max_torque
6074h: torque_demand_value
6075h: motor_rated_current
6076h: motor_rated_torque
6077h: torque_actual_value
6078h: current_actual_value
6079h: dc_link_circuit_voltage
6087h: torque_slope
6088h: torque_profile_type
60F8h: torque_control_parameters
2010h: rated_voltage
2070h: current_control_parameter_set
2074h: target_current_q
2075h: reference_current_q
2077h: reference_torque
2078h: rated_torque_constant
207Bh: Torque command low pass filter

ORDERING INFORMATION:

Standard model: DC201R30A40NACX

With sourcing inputs: DC201R30A40NACX-SRC

X indicates the current revision letter.

MOUNTING DIMENSIONS:

